

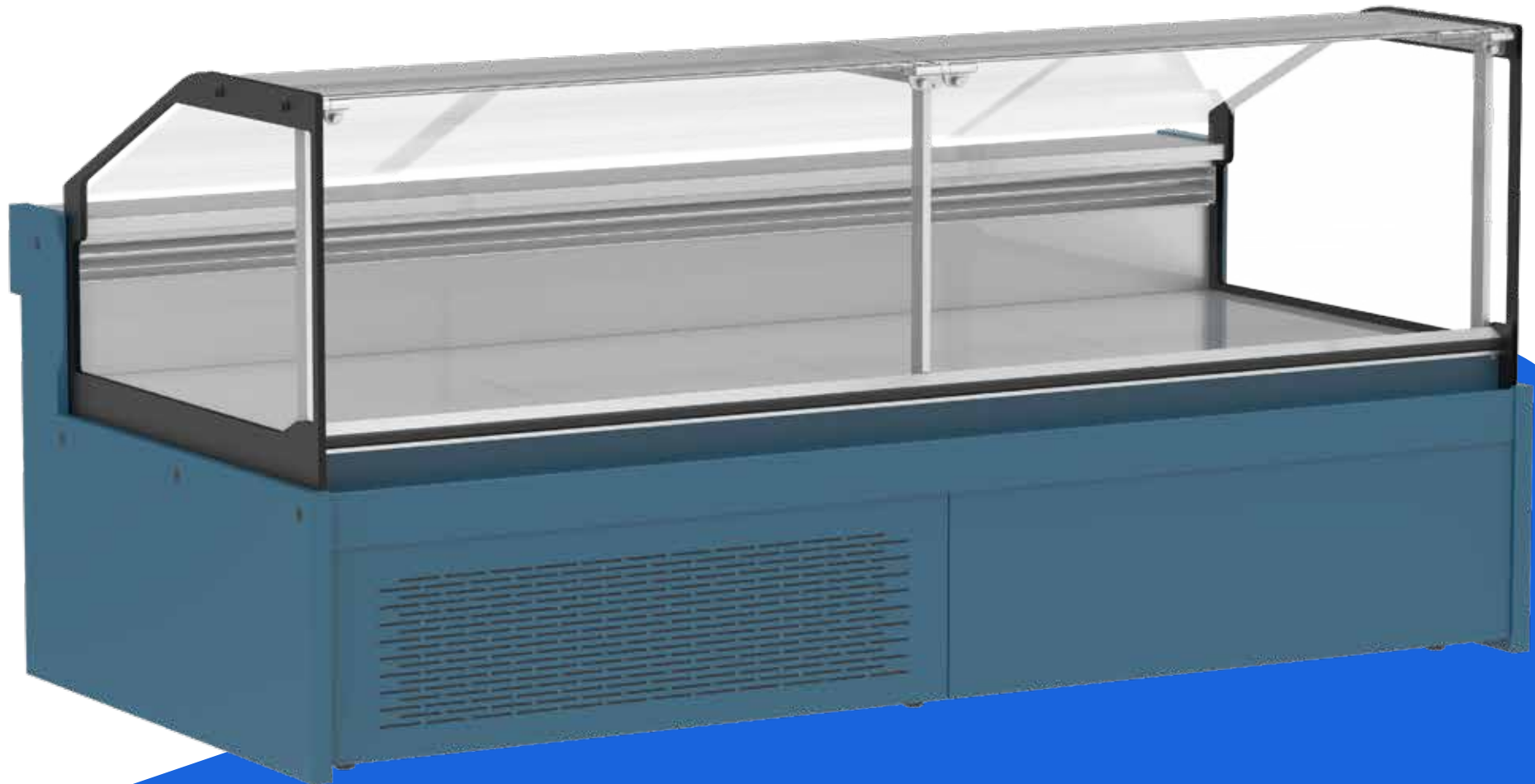

PARRY

Plug-in Refrigerated Serve Over Counter With Flat Glass



Plug-in Refrigerated Serve Over Counter

PARRY

Technical Details

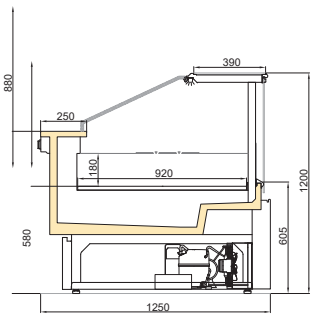

PARRY 900 FG

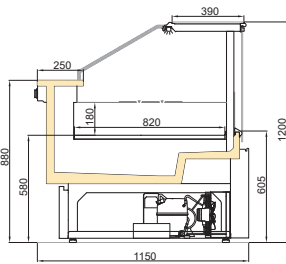

PARRY 800 FG

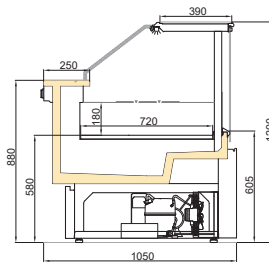

PARRY 700 FG

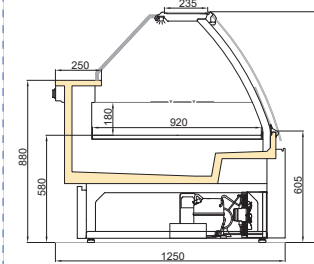

PARRY 900 CG

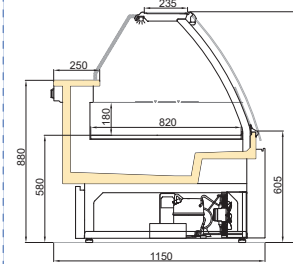

PARRY 800 CG

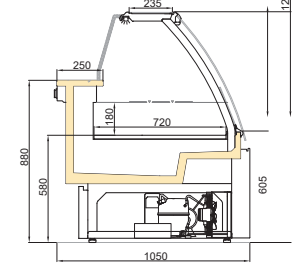

PARRY 700 CG

Available Modules				
Length(mm/in)	937/36.8	1250/49.2	1875/73.8	2500/98.4
Side panel(mm/in)	40/1.57	40/1.57	40/1.57	40/1.57
Operating Temperatures		Ambient Conditions		
M1 (-1/+5 °C) - M2 (-1/+7 °C)		25°C / 60% RH (EN ISO 23953-2)		

